

NAIS

**DIN24 SIZE
MULTI-RANGE ANALOG TIMER**

**PM5S-A
PM5S-S
PM5S-M**

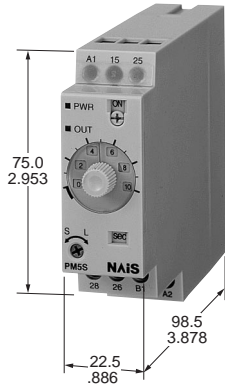

mm inch

C-UL File No.: E59504 (Vol. 3)

FEATURES

- 24-240V AC/DC free-voltage input
- Built-in Screw terminals and DIN rail mount
- 6 different operation modes: (PM5S-A; -M)
- Multiple time ranges — 1 s to 500 h (Max.)
- Slim body — DIN 22.5 mm .886 inch
- 0 setting instantaneous output operation
- UL/CSA/CE approval



PRODUCT TYPE

Type	Operation mode	Contact arrangement	Time range	Protective construction	Rated operating voltage	Part No.
PM5S-A	6 operation modes • Pulse ON-delay • Pulse Flicker • Pulse ON-flicker • Signal OFF-delay • Pulse One-shot • Pulse One-cycle	Relay Timed-out 2 Form C	16 selectable ranges 1s to 500h	IP40	24 to 240V AC/DC	PM5S-A-24-240V
PM5S-S	Power ON-delay	Relay Timed-out 2 Form C				PM5S-S-24-240V
PM5S-M	6 operation modes (With instantaneous contact) • Pulse ON-delay • Pulse Flicker • Pulse ON-flicker • Signal OFF-delay • Pulse One-shot • Pulse One-cycle	Relay Timed-out 1 Form C Instantaneous 1 Form C				PM5S-M-24-240V

TIME RANGE

Scale	Time unit	Time range			
		sec	min	hrs	10h
1	Control time range	0.1s to 1s	0.1 min to 1 min	0.1h to 1h	1.0h to 10h
5		0.5s to 5s	0.5 min to 5 min	0.5h to 5h	5h to 50h
10		1.0s to 10s	1.0 min to 10 min	1.0h to 10h	10h to 100h
50		5s to 50s	5 min to 50 min	5h to 50h	50h to 500h

PM5S-A/PM5S-S/PM5S-M
All PM5S timers have 16
selectable time ranges
from 1s to 500h (Max.
range).

Note: 0 setting is for instantaneous output operation.

CHARACTERISTICS

Item	Type	PM5S-A	PM5S-S	PM5S-M
Rating	Rated operating voltage	24 to 240V AC/DC		
	Rated frequency	50/60Hz common		
	Rated power consumption	2.6 VA (AC), 1.4 W (DC)		
	Output rating	5A 250V AC (resistive load)		
	Operating mode	Pulse ON-delay Pulse Flicker Pulse ON-Flicker Signal OFF-delay Pulse One-shot Pulse One-cycle	Power ON-delay	Pulse ON-delay Pulse Flicker Pulse ON-flicker Signal OFF-delay Pulse One-shot Pulse One-cycle (with instantaneous contact)
Time accuracy (Note:)	Time range	1s to 500h (Max.) 16 time ranges switchable		
	Operating time fluctuation	±0.3% (power off time change at the range of 0.1s to 1h)		
	Setting error	±10% (Max. setting time value)		
	Voltage error	±0.5% (at the operating voltage changes between 85 to 110%)		
Contact	Temperature error	±2% (at 20 C ambient temp. at the range of -10 to +55 C +14 to +131 F)		
	Contact arrangement	Timed-out 2 Form C	Timed-out 1 Form C Instantaneous 1 Form C	
	Contact resistance (Initial value)	Max. 100mΩ (at 1A 6V DC)		
Life	Contact material	Silver alloy	Au flash on Silver alloy	
	Mechanical (contact)	2 10 ⁷	1 10 ⁷	
	Electrical (contact)	10 ⁵ (at rated control capacity)		
Electrical function	Allowable operating voltage range	85 to 110% of rated operating voltage (at 20 C coil temp.)		
	Insulation resistance (Initial value)	Min. 100MΩ	Between live and dead metal parts Between input and output Between contacts of different poles Between contacts of same pole	(At 500V DC)
	Breakdown voltage (Initial value)	2,000Vrms for 1 min Between live and dead metal parts 2,000Vrms for 1 min Between input and output 2,000Vrms for 1 min Between contacts of different poles 1,000Vrms for 1 min Between contacts of same pole		
	Min. power off time	100ms		
	Max. temperature rise	55 C 131 F	65 C 149 F	
Mechanical function	Shock resistance	Functional	Min. 98m/s ² (4 times on 3 axes)	
		Destructive	Min. 980m/s ² (5 times on 3 axes)	
	Vibration resistance	Functional	10 to 55Hz: 1 cycle/min Single amplitude of 0.35mm (10min on 3 axes)	
		Destructive	10 to 55Hz: 1 cycle/min Single amplitude of 0.75mm (1h on 3 axes)	
Operating condition	Ambient temperature	-10 to +55 C +14 to +131 F		
	Ambient humidity	Max. 85%RH		
	Atmospheric pressure	860 to 1,060hPa		
	Ripple factor (DC)	20%		
Others	Protective construction	IP40		
	Weight	120g 4.233 oz		

Note: 1) Unless otherwise specified, the measurement conditions at the maximum scale time standard are specified to be the rated operating voltage (within 5% ripple factor for DC), 20°C 68°F ambient temperature, and 1s power off time.
2) For the 1s range, the tolerance for each specification becomes ±10ms.

WIRING DIAGRAMS

PM5S-A

- Timed-out 2 Form C

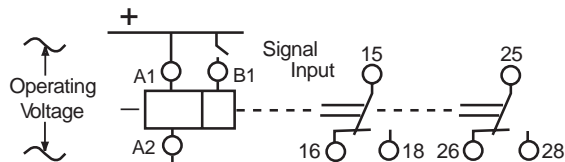

PM5S-S

- Timed-out 2 Form C

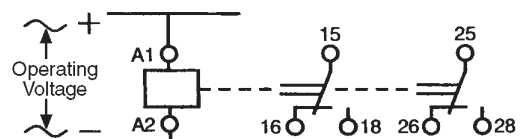

PM5S-M

- Timed-out 1 Form C
- Instantaneous 1 Form C

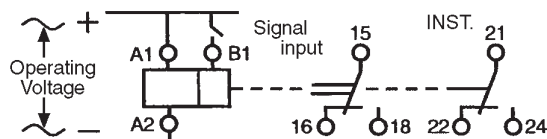

Contact

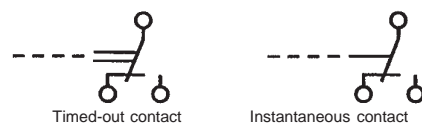

MODE SELECTION

PM5S-A/M type

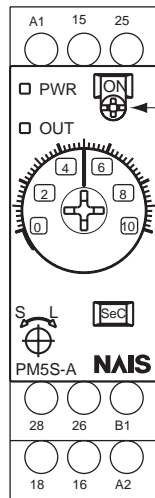

Operation mode selector & indicator

Selects from 6 operation modes

ON: ON-delay

FL: Flicker

FO: ON-flicker

SF: Signal OFF-delay

OS: Pulse One-shot

OC: Pulse One-cycle

The 6 operating modes (PM5S-A and PM5S-M) can be selected by the operation mode selector switch.

DIMENSIONS

mm inch



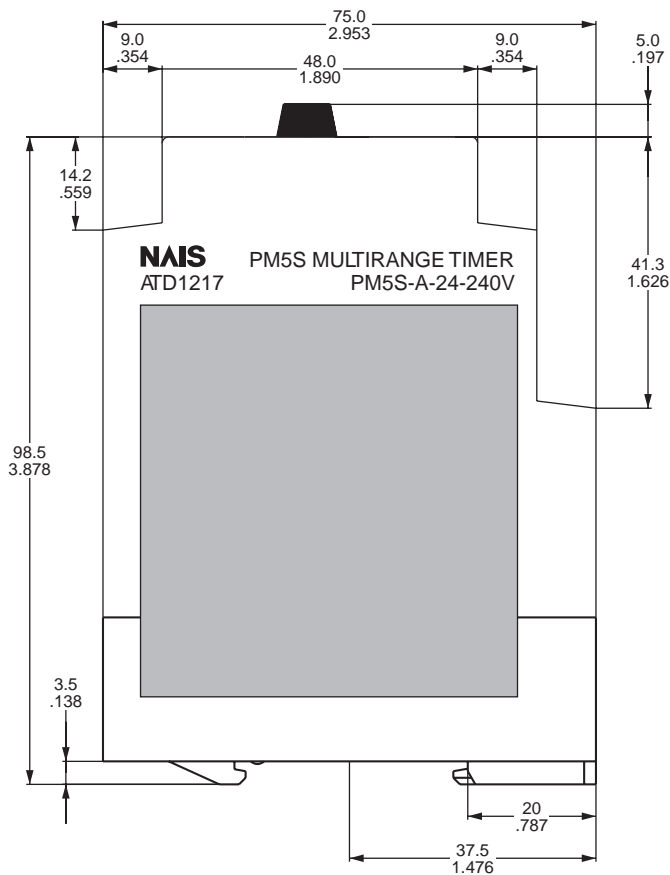
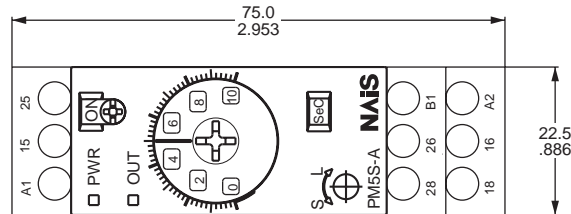





PM5S-□

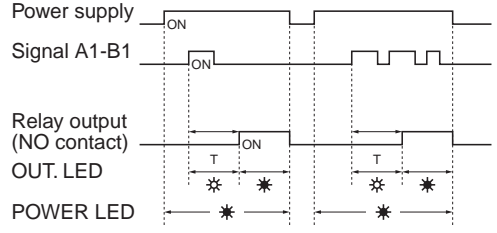

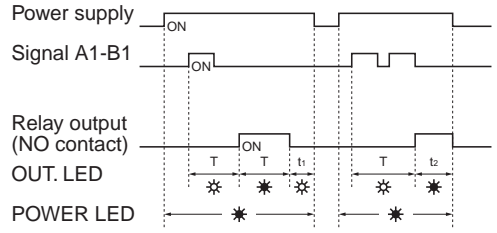

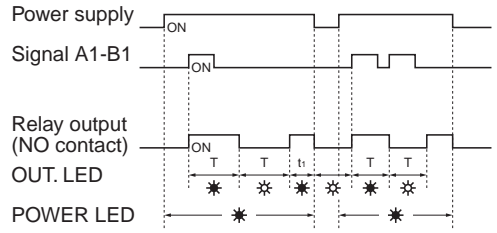
OPERATION MODE

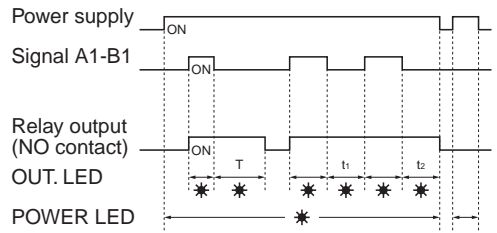
PM5S-A/M

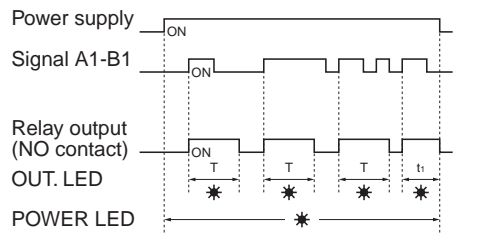
(* LED lighting * LED flickering)
 T: Setting time $t_1, t_2 < T$

Operation mode	Operation	Time chart
ON-delay 	Turn the operation selector to ON . Timing operation starts when terminals A1 – B1 are connected while power is on. Control output is turned ON after the set time regardless of the duration of the set signal. Additional signal inputs are ignored. The timer resets when power is removed.	
Flicker 	Turn the operation selector to FL . Timing operation starts when terminals A1 – B1 are connected while power is on. Control output remains OFF for the first set time period then repeatedly turns ON and OFF for the set time. Additional signal inputs are ignored. The timer resets when power is removed.	
ON-flicker 	Turn the operation selector to FO . Control output turns ON and the timing operation starts when terminals A1 – B1 are connected while power is on. Control output repeatedly turns OFF and ON for the set time. Additional signal inputs are ignored. The timer resets when power is removed.	
Signal OFF-delay 	Turn the operation selector to SF . The Control output turns ON when terminals A1-B1 are connected while power is ON. Timing operation starts when terminals A1 – B1 are opened while power is on. Control output is turned off after the set time. If the signal input turns ON during timing operation, the timing operation stops and resets. When the signal input turns OFF again, timing will begin.	
One-shot 	Turn the operation selector to OS . Timing operation starts when terminals A1 – B1 are connected while power is ON. Control output remains ON during the timing operation.	

Note: Allow 0.1s or more for power off time.
 Allow 0.05s or more for signal input time.

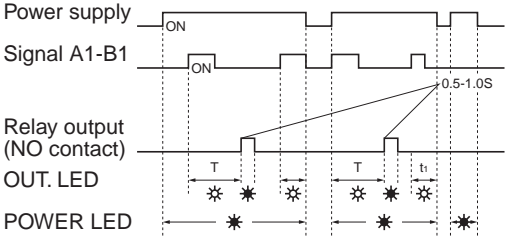
Operation mode	Operation	Time chart
One-cycle 	Turn the operation selector to  . Timing operation starts when terminals A1-B1 are connected while power is ON. The Control output is turned ON after the set time for a fixed duration between 0.5 and 1.0 seconds. Additional inputs are ignored during timing.	

Note: Allow 0.1s or more for power off time.
 Allow 0.05s or more for signal input time.

OPERATION MODE

PM5S-S



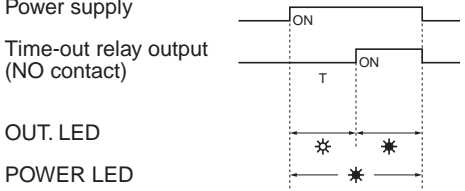



(* LED lighting * LED flickering)
 T: Setting time

Operation mode	Operation	Time chart
Power ON-delay	When power is applied continuously, the time cycle begins. The Control output is turned ON after the set time. The timer resets when power is removed.	

MODES & TIME SETTING

1) Operation mode setting [PM4H-A]

6 operation modes are selectable by turning the operation mode selector with a screw driver.

The operation mode is shown in the window above the mode selector. Mode indicators include , , , , , . Turn the mode selector to the desired mode. Confirm that the mode indicator is properly positioned in the window. If the indicator is not positioned correctly, the timer might not operate properly.

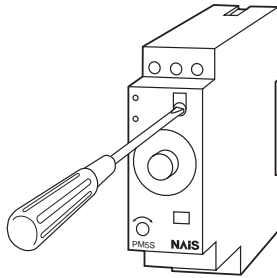

2) Time setting [common]

16 time ranges are selectable between 1s to 500h full scale.

Turn the time range selector with a screw driver.

Turning clockwise increases the time range, turning counterclockwise decreases the time range.

Confirm that the range units indicator and number values are properly positioned in their windows.

3) Time setting [common]

To set the time, turn the set dial to a de-

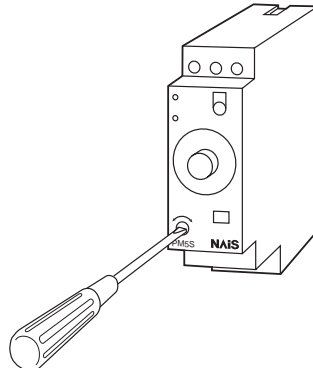

sired time within the range. Do not turn the dial beyond the stopper.

Control output ON will be instantaneous when the dial is set to, or under, "0".

This is the Instantaneous Output area.

When power is applied, the time range, setting time and operation mode cannot be changed.

Turn off the power supply before changing these values.

• Cautions for Time setting/Operating mode setting

1) Time chart

- T indicates the setting time, t1 and t2 represent time periods less than the setting time. (t1, t2 < T)

- When the Control output relay is turned ON, the NO contact is closed and the NC contact is opened.

- Red LED indication * shows Control output turned ON.

2) Timing operation starts when terminals A1 – B1 are connected while power is ON.

Minimum input signal time should be greater than 0.05 sec.

Short-circuited condition: Max. 1kΩ

Open-circuited condition: Min. 100kΩ

Input Connections

The inputs of the PM5S-A/M are voltage (voltage imposition or open) inputs.

Non-contact input
(Connection to PNP output sensor.)

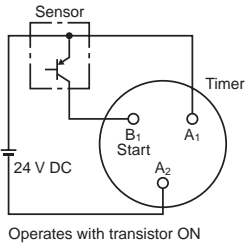

Contact input

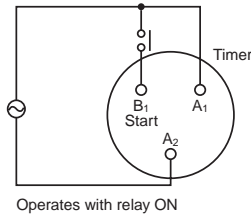

Non-contact input	1. Transistor ON Residual voltage: 1 V max. (Voltage between terminals B ₁ and A ₂ must be more than the rated "H-level" voltage (20.4 V DC min..))
	2. Transistor OFF Leakage current: 0.01 mA max. (Voltage between terminals B ₁ and A ₂ must be less than the rated "L-level" voltage (2.5 V DC max..))
Contact input	Use contacts that can adequately switch 0.1 mA at each voltage to be imposed. (When the contacts are ON or OFF, voltage between terminals B ₁ and A ₂ must be within the following ranges: When contacts are ON: 20.4 to 264 V AC/DC When contacts are OFF: 0 to 2.5 V AC/DC

Mounting and Dismounting

The PM5S should be mounted as horizontally as possible. When mounting the PM5S on a DIN rail, hook portion (A) of the Timer to an edge of the rail first, and then press the Timer in the direction of (B).

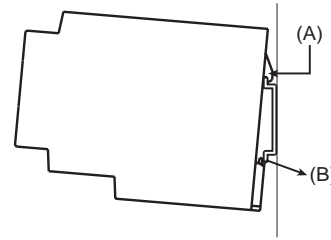

When dismantling the PM5S, pull out tab (C) with a flat-blade screwdriver and remove the Timer from the DIN rail.

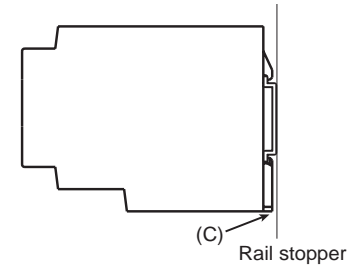

CAUTIONS FOR USE

Cautions

1) Do not use the timer in where flammable or corrosive gas is generated, a lot of dust exists, oil is splashed, or considerable shock and vibration occur.

2) Since the timer body consists of polycarbonate resin, avoid contact with organic solvents such as methyl alcohol, benzene and thinner, or strong alkali materials such as ammonia and caustic soda.

Power Supplies

The PM5S Series incorporates a transformerless power supply. An electric shock may be received if the input terminal or the output type selector switch is touched while power is being supplied.

Solid copper wire is recommended for wiring the PM5S. Using stranded-wire may cause a short-circuit due to a stray wire strand entering the Timer.

For the power supply of the input device, use a single-phase or double-phase insulated power transformer. The secondary side must not be grounded.

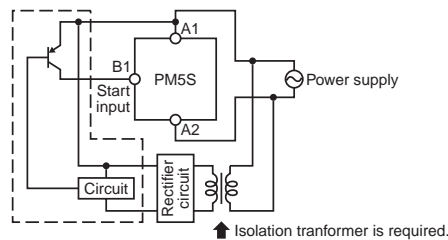

• Input and Power supply circuit

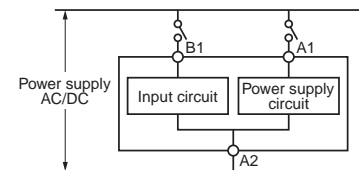

(PM5S-A/M)

• Since the input and power supply circuits are independent, it is possible to switch simultaneous input circuits ON and OFF regardless of independent power supply status.
Note that the input circuit contact is at the same voltage as the power supply.

Terminal Connections

- Refer to the terminal layout and wiring diagram and securely connect the terminals accordingly.
- Do not allow control output to exceed rated control capacity.

1. When one input signal is simultaneously applied to more than one timer, be sure to avoid the wiring shown in Fig. A. Otherwise, the short-circuit current will damage the timer. Be sure to align the polarity of the power supply as shown in Fig. B.

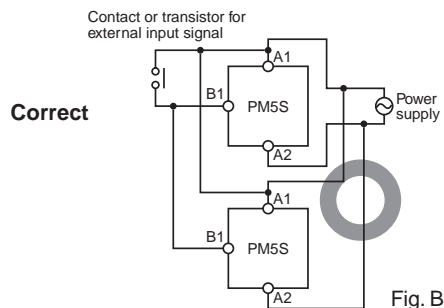
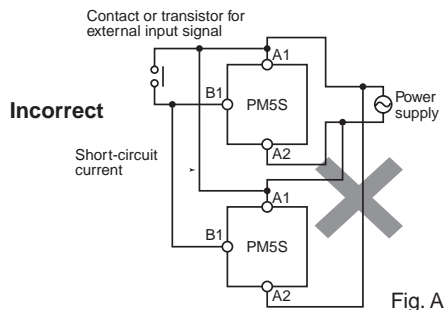

The PM5S series is provided with a transformerless power supply.

2. External surge protection may be required if the following values are exceeded. Otherwise, the internal circuit will be damaged.

Operating voltage	24 to 240 V AC
Surge voltage	4,000 V

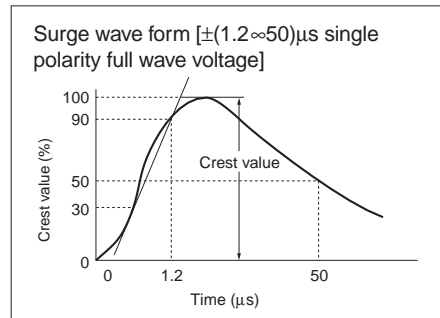

3. For connecting and disconnecting operating voltage to the timer, a circuit should be used to prevent the flow of leakage current. For example, a circuit for contact protection as shown in Fig. C will permit leakage current to flow through R and C, causing erroneous operation of the timer. Instead, the circuit shown in Fig. D should be used.

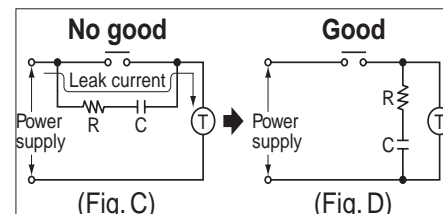

4. In order to maintain the operating characteristics of the timer, long continuous current flow through the timer (causing generation of heat internally) should be avoided. For such long continuous operation, the circuit shown below should be used.

